

USING THE W12GTi IN SPL COMPETITION

The enclosures presented here provide maximum SPL over a narrow range of frequencies and are optimized for SPL competition. These designs use a non-classical alignment in which the vented enclosure's resonance is carefully aligned with the response of a sealed box of the same volume to produce a peak in the system's output slightly above the tuning frequency. This peak may be as much as 12 dB when compared to a sealed box aligned for flat response.

Because all woofers operate as though they were un baffled below vented enclosure resonance (i.e., tuning frequency) and because the tuning frequencies of these boxes is higher those of vented enclosures optimized for low-frequency extension and flat response in the passband, these woofer/enclosure combinations will not handle rated power **below** resonance.

If you use these enclosures for competition *and* everyday listening, you may find the sharp response peak unsuitable when listening to music. Try closing the vent(s) to provide an acceptable response for music reproduction. However, do not forget to open them for the next competition!

When you are competing (using one of these woofer/enclosure combinations), choose a short-duration sine wave test signal that corresponds in frequency for the enclosure you have selected. Be careful not to apply too much power at frequencies more than one-half octave below the enclosure's tuning frequency.

ABOUT POWER COMPRESSION

For best performance in SPL competition, we recommend minimizing the time a woofer is played at exceedingly high input levels. As the woofer's voice coil heats, its dc resistance will temporarily increase and cause the amplifier to produce less power.

GTi woofers employ dual voice-coils, dual ultra-long gaps, and a magnet heatsink to quickly

dissipate heat generated in the voice coil, and are less susceptible to power compression than ordinary woofers.

Ideally, the test signal should be very short and repeated only after the voice coils have cooled, as the first test will be the loudest.

NOTE: Exciting the system after the voice coil is hot will result in lower SPL readings.

VENTED BOX VOLUME FOR 60 HZ TEST (INCLUDES DRIVER/PORT DISPLACEMENTS)

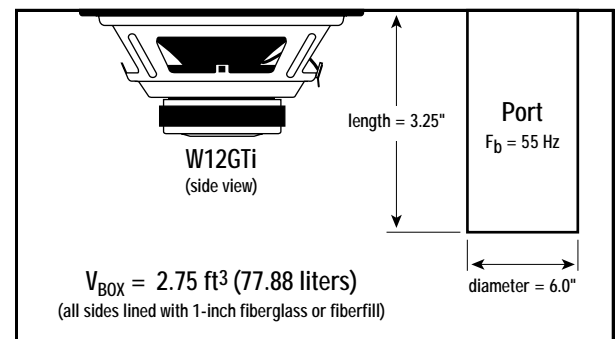

VENTED FREQUENCY RESPONSE @ 2.83 V

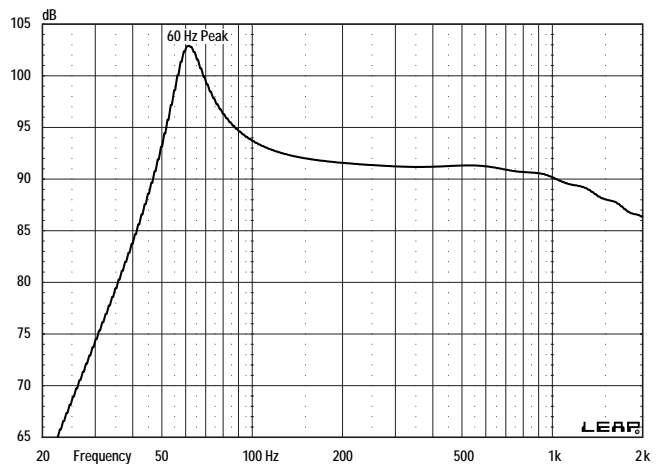

continued on the back...



W12GTi 12" Woofer – Technical Data

VENTED BOX VOLUME FOR 65 HZ TEST (INCLUDES DRIVER/PORT DISPLACEMENTS)

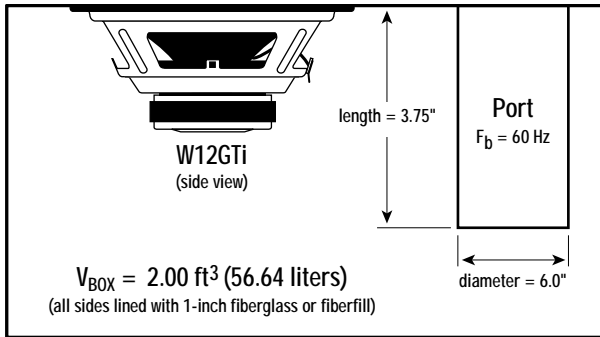

VENTED BOX VOLUME FOR 70 HZ TEST (INCLUDES DRIVER/PORT DISPLACEMENTS)

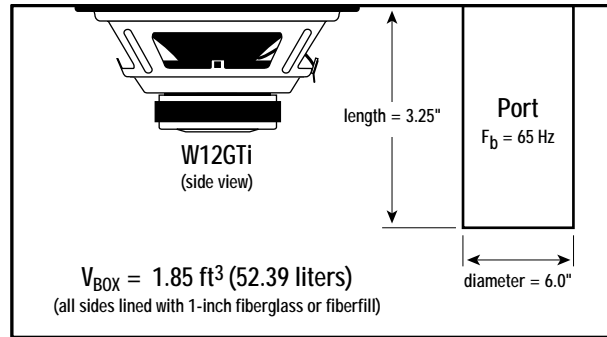

VENTED FREQUENCY RESPONSE @ 2.83 V

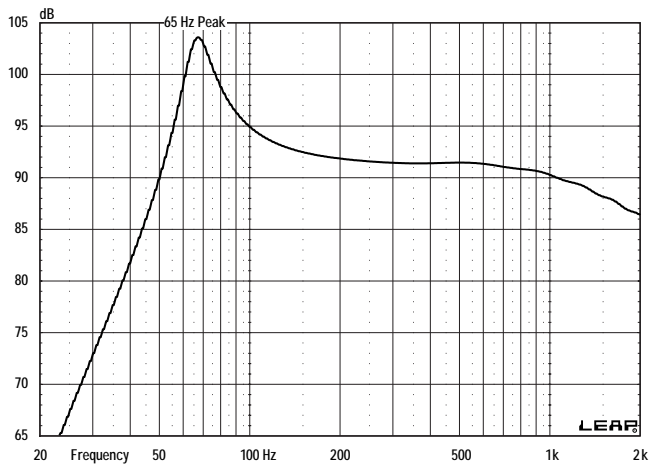

VENTED FREQUENCY RESPONSE @ 2.83 V

